

HAUPTSTÄNDER

Centre stand | Caballete central | Béquille centrale | Cavalletto centrale

Art.-Nr: 32422-002/32423-002

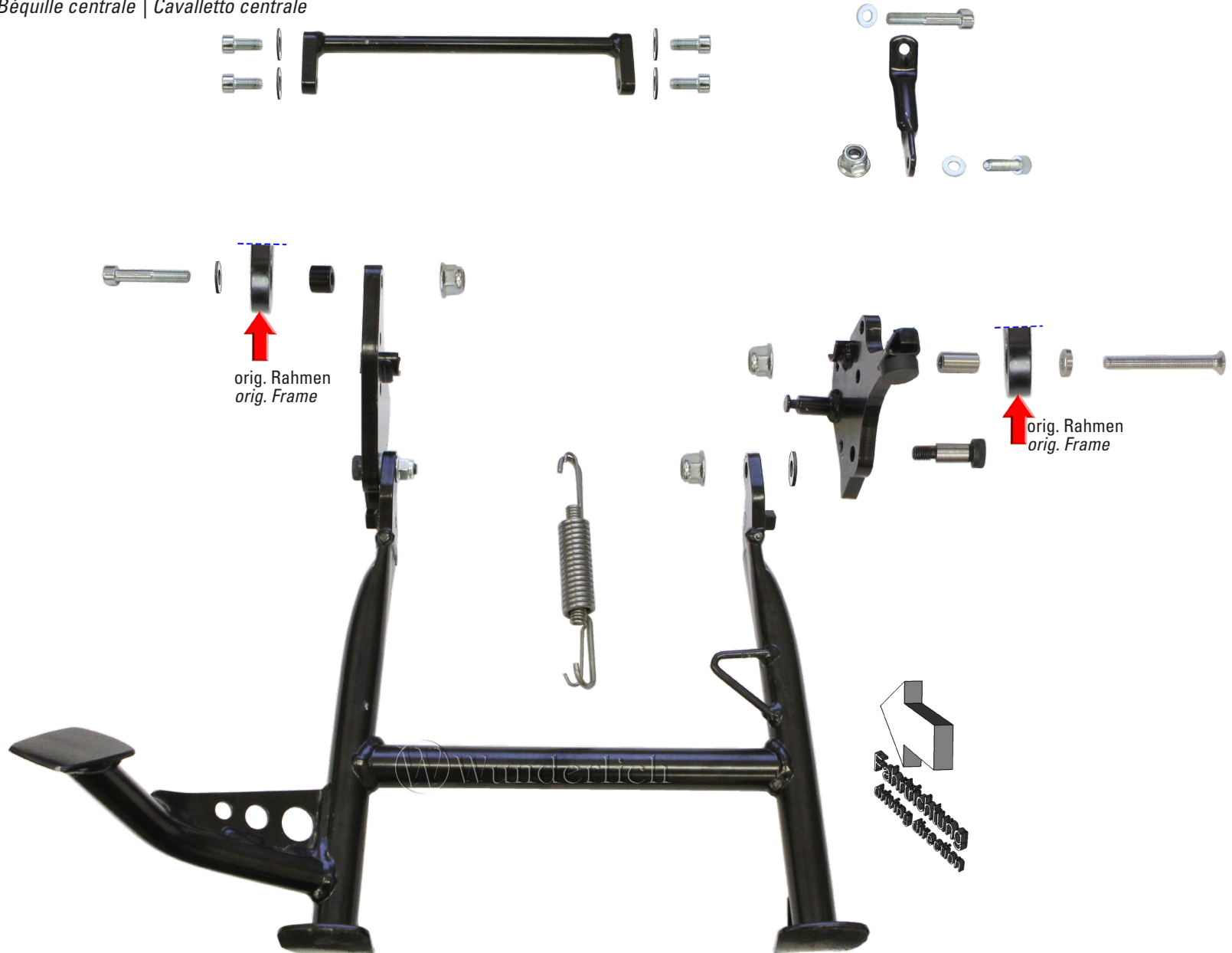

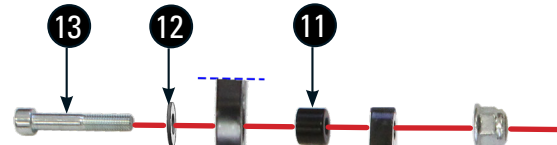
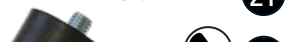
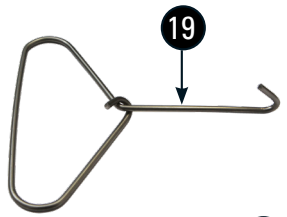

orig. Rahmen
orig. Frame

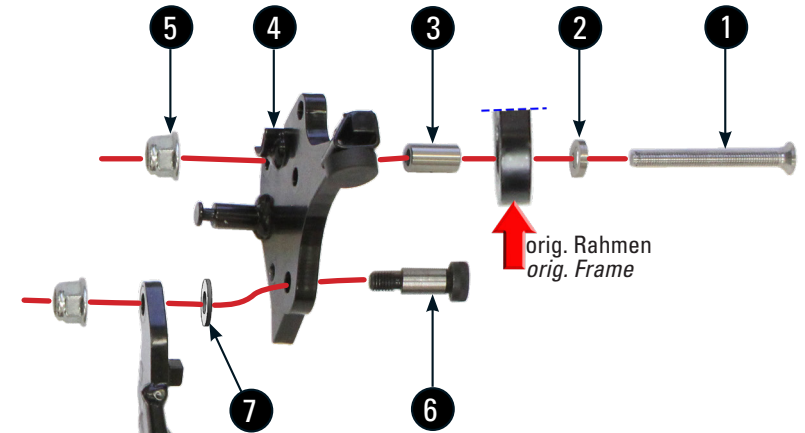

orig. Rahmen
orig. Frame

#	BEZEICHNUNG	MENGE
1	Senkkopfschraube M8 x 80	1
2	Rosette Senkkopf	1
3	Hülse D=13,5/ d=8,5/ Modellabhängig h=25,0/27,0mm	1
4	Halter rechts	1
5	Sechskantmutter mit Flansch, selbstsichernd M8	5
6	Bundschraube M8	2
7	U-Scheibe Teflon M10	2
8	Hauptständer	1
9	Doppelfeder	1
10	Halter links	1
11	Hülse D=18,0 / d=8,5 / h=13,5mm	1
12	U-Scheibe M8	7
13	Zylinderkopfschraube niedriger Kopf M8 x 50	1
14	Zylinderkopfschraube M8 x 20 19Nm	4
15	Querstrebe	1
16	Zylinderkopfschraube Inbus M8 x 60 19Nm	1
17	Verdrehsicherung	1
18	Zylinderkopfschraube niedriger Kopf M8 x 30	1
19	Federzieher	1
20	Sechskantmutter M6	1
21	U-Scheibe M6	1
22	Anschlagpuffer	1
23	Moosgummi	10cm

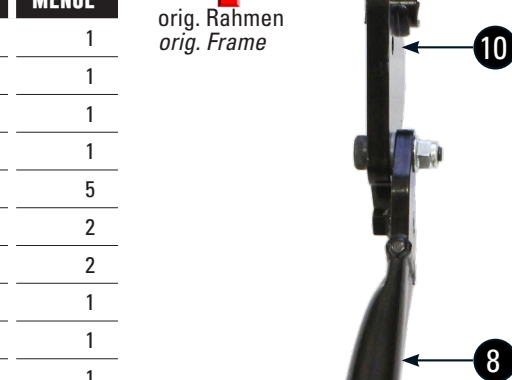
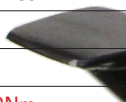

Wunderlich

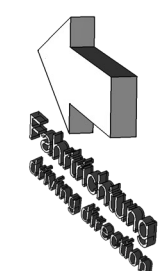



Markierte Fläche mit Moosgummi bekleben!
Cover the marked area with sponge rubber!

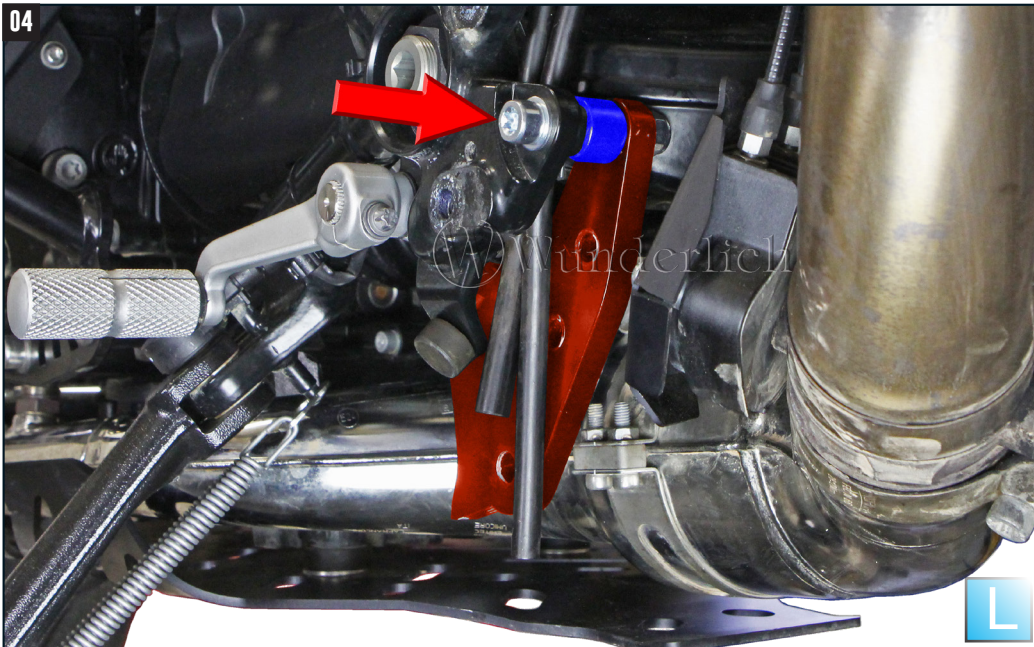

Linken Halter vormontieren und später fest verschrauben!
Pre-assemble the left bracket and tighten it later on!

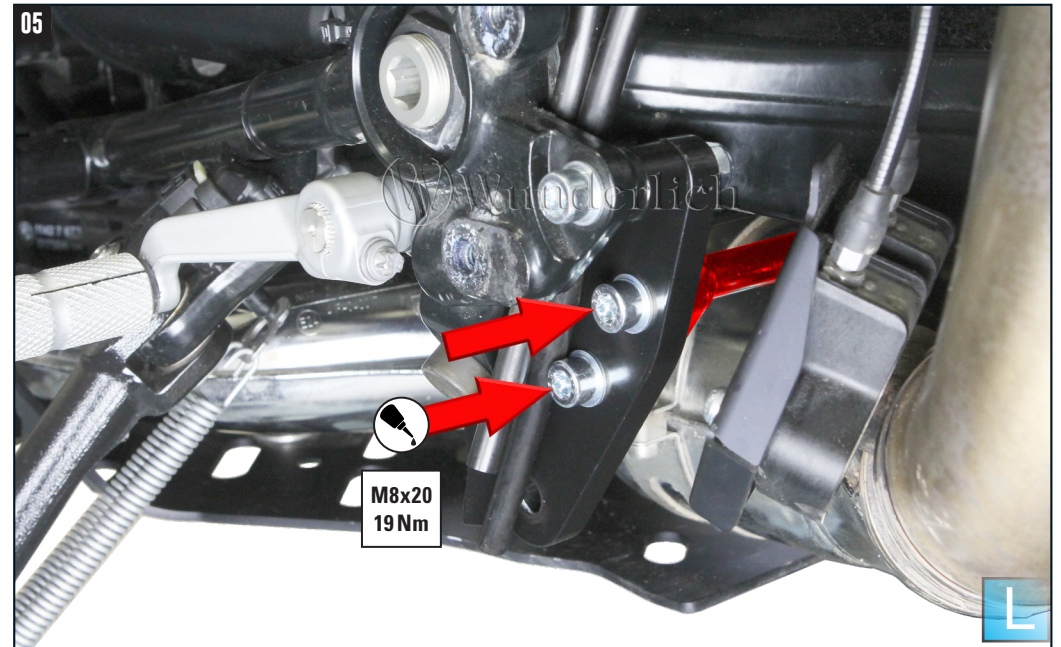

Querstrebe montieren!
Mount the cross brace!

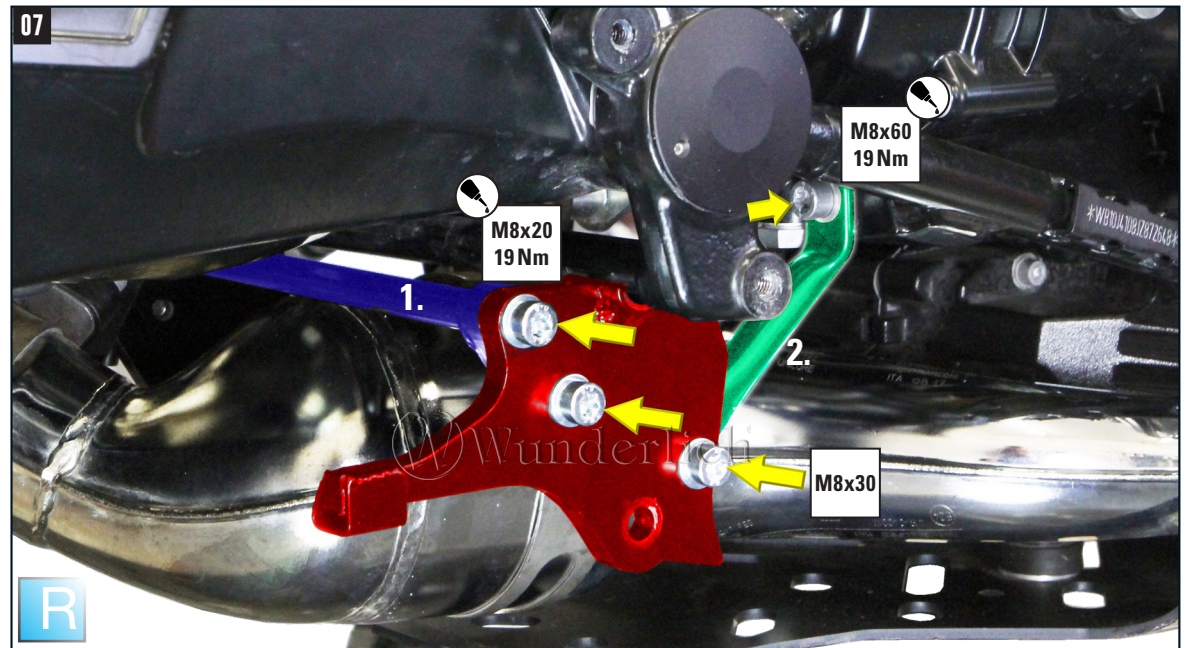
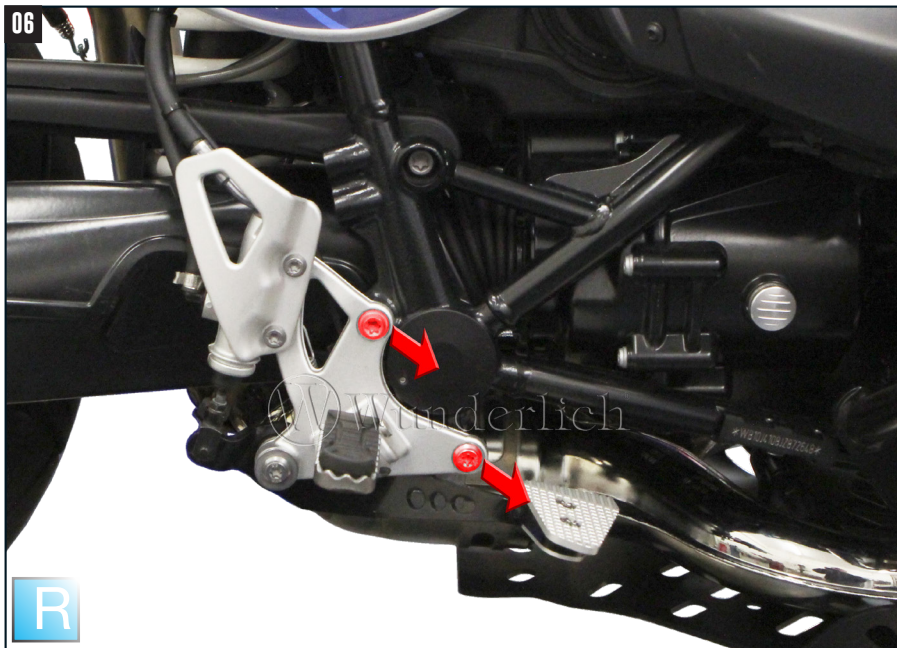

1. Rechten Halter mit der Querstrebe verschrauben. **2.** Verdrehsicherung vornontieren und später fest verschrauben!
1. Bolt the right bracket to the cross brace. **2.** Pre-assemble the rotation lock and tighten it later on!

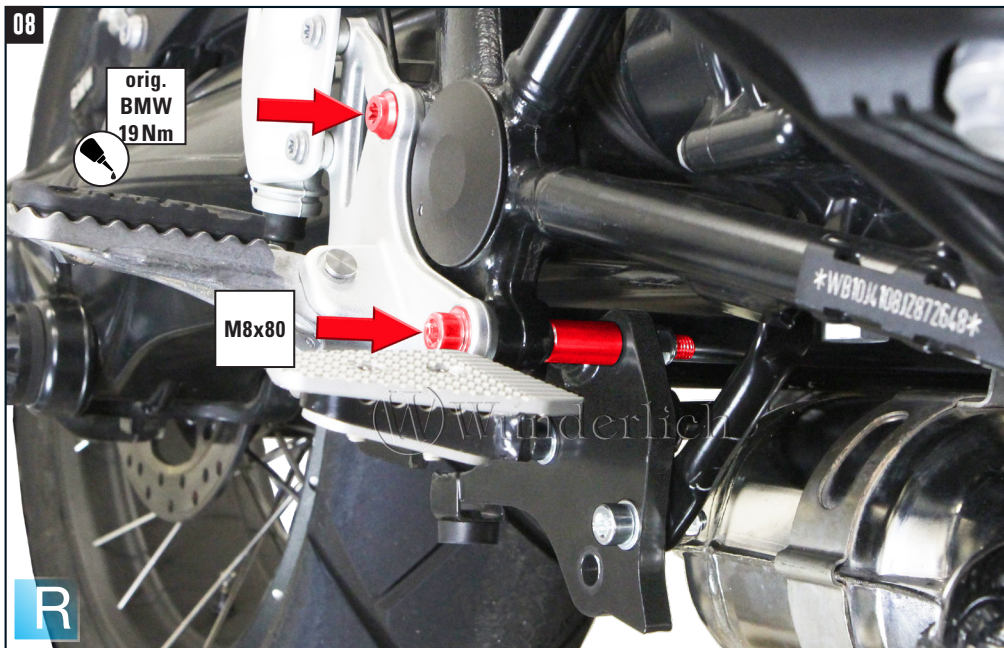

Hülse / spacer D=13,5/ d=8,5/ h= 25,0mm **Je nach Modell muss eine der beiden Hülsen verwendet werden.**
Hülse / spacer D=13,5/ d=8,5/ h= 27,0mm **Depending on the model, use one of the sleeves.**

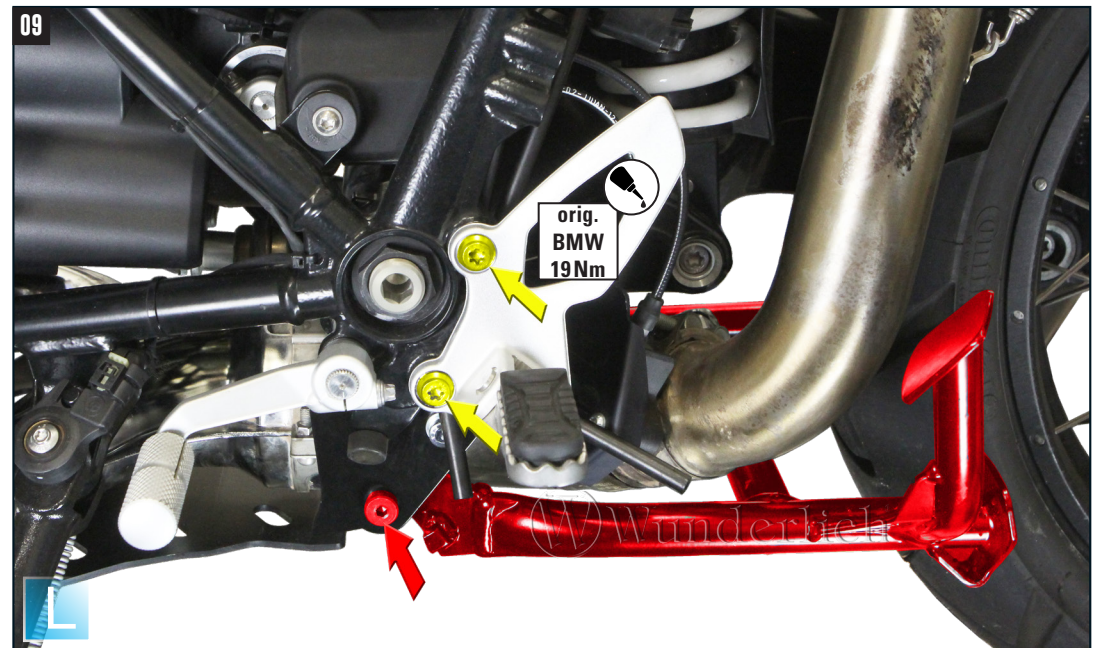

1. Rastenträger montieren **2.** Hauptständer lose vormontieren!
1. Mount the footrest support. **2.** Loosely pre-assemble the centre stand!

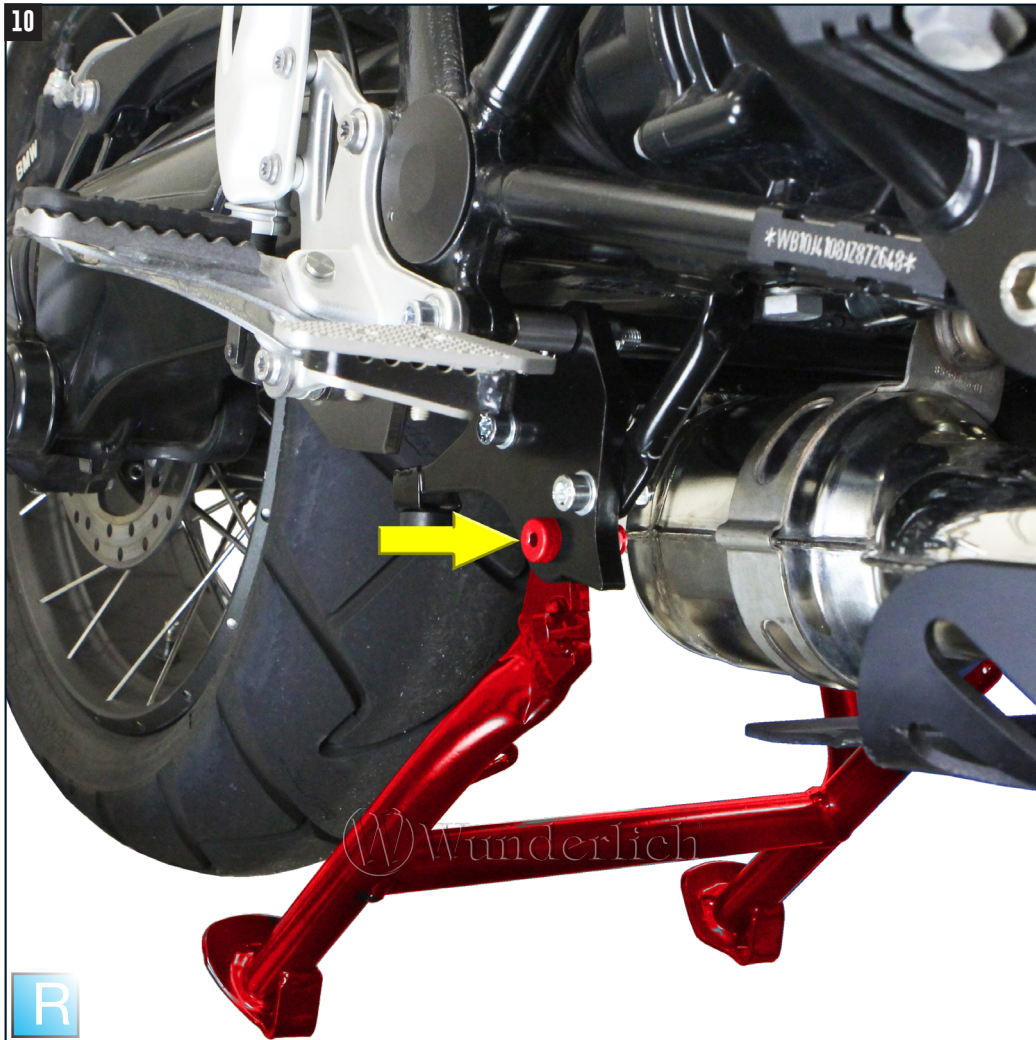

Spannfedern nacheinander mit Federzieher einhängen. Alle Schrauben festziehen und den Hauptständer auf Freigängigkeit prüfen!
 Mount the springs one after the other by using a spring puller. Tighten all screws and check the clearance of the centre stand!