

SCHALTHEBELVERGRÖßERUNG









Gear lever enlargement | Boîte à outils | Caja de herramientas | Cassetta degli attrezzi

Artikel.-Nr: **18200-00X**

REV01



LEGENDE/KEY/FILE LÉGENDE

-  **Anbau Tipp**
Fitting tip
Astuce de montage
-  **Achtung**
Attention
Attention
-  **Vergrößerung**
Magnification
Grossissement
-  **Montagepaste**
Fitting lubricant
Lubrifiant de montage
-  **Zusammenbauen**
Assemble
Assembler
-  **Schraubensicherung**
Thread locking fluid
Freinilets
-  **Drehmoment**
Torque
Torque
-  **Gummi Hammer**
Rubber Hammer
Marteau en caoutchouc



| BEZEICHNUNG / DESCRIPTION | | DE EN FR | | | DIN | ISO | MENGE QUANTITY |
|------------------------------|--|--|---------|------|-------|-----|-------------------|
| 1 | | Schalthebelvergrößerung / Gear lever enlargement | | | | | 1 |
| 2 | | Zylinderschraube / Cylinder screw | M8 x 45 | 7991 | 10642 | 1 | |

DIE NR. 1 WELTWEIT FÜR HOCHWERTIGES BMW MOTORRADZUBEHÖR.

01

 **Wunderlich**
complete your BMW.

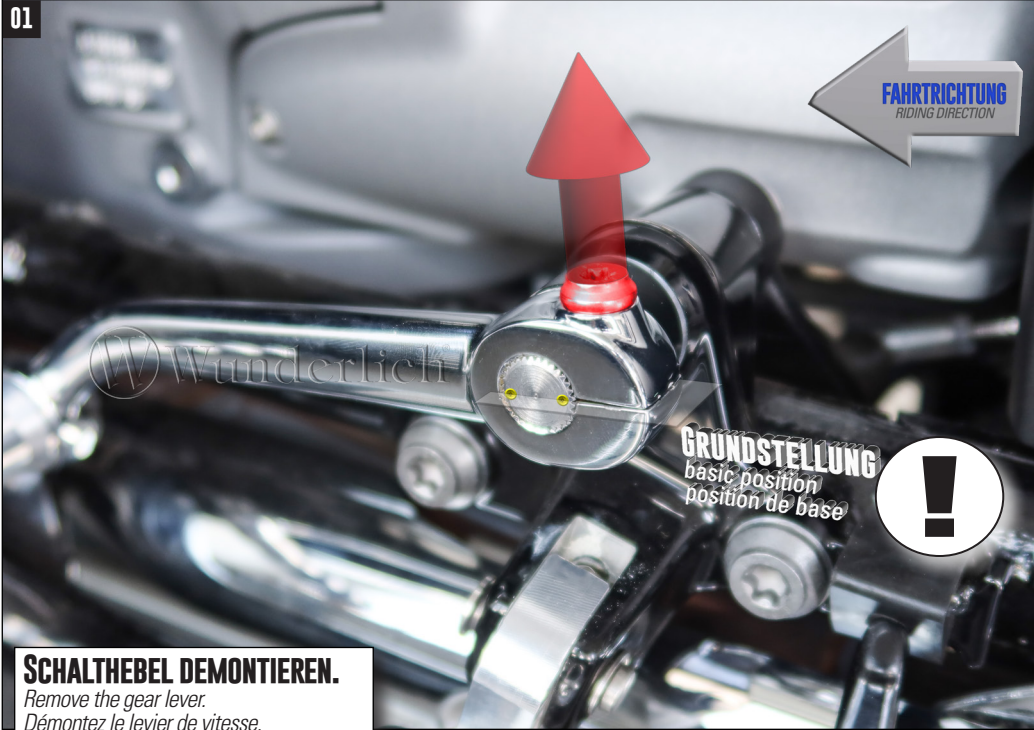

SCHALTHEBEL DEMONTIEREN.

Remove the gear lever.
Démontez le levier de vitesse.

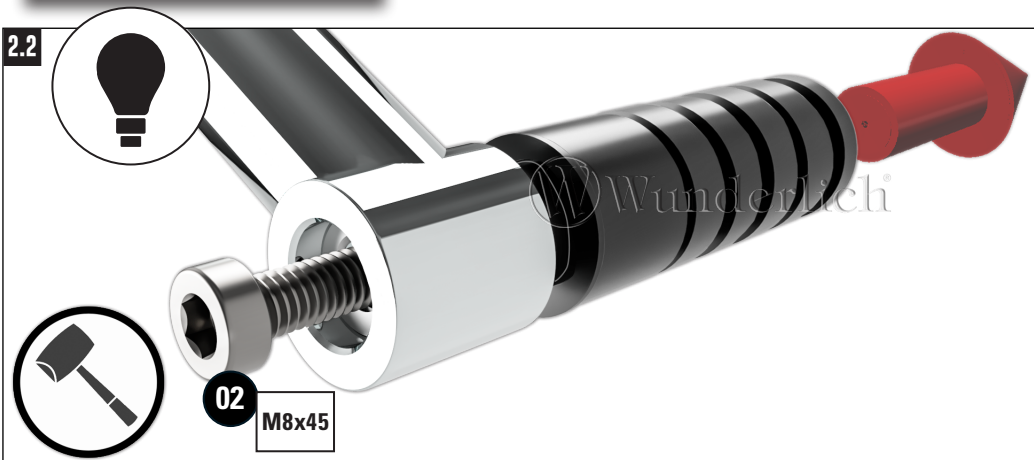
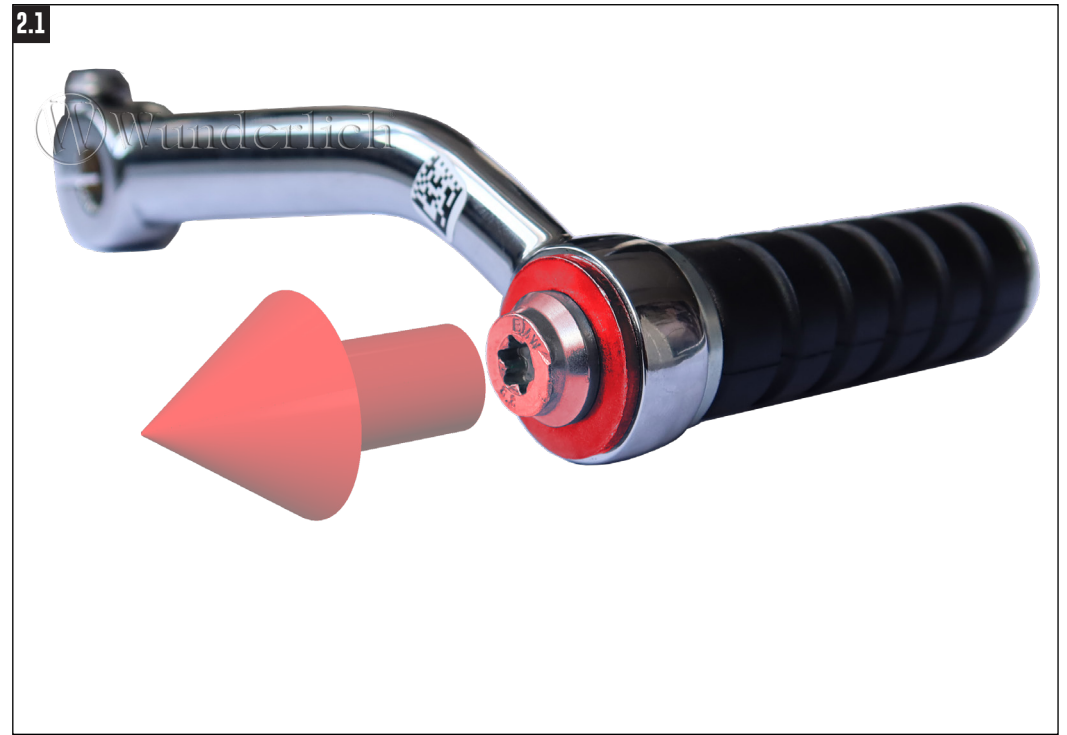

Schraube M8x45 wird nur zum Austreiben bzw. -pressen des orig. Hebels benötigt. Um das Austreiben / -pressen zu erleichtern und Schäden an der Beschichtung zu vermeiden, empfehlen wir das vorherige Erwärmen der Hebelaufnahme.

M8x45 screw is only needed to drive out or press out the original lever. To make the driving out / pressing out easier and to avoid damage to the coating, we recommend heating the lever mount before.

La vis M8x45 n'est nécessaire que pour extraire ou repousser le levier d'origine. Pour faciliter l'extraction et éviter d'endommager le revêtement, nous vous recommandons de chauffer le support du levier avant de l'extraire.

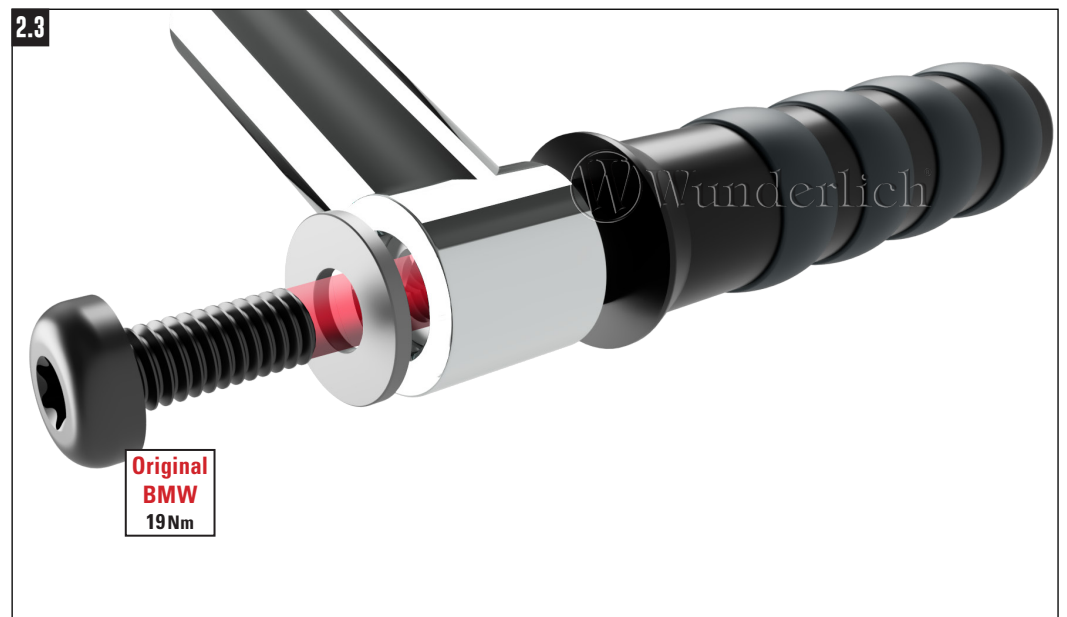



Original
BMW
9Nm 



GRUNDSTELLUNG
basic position
position de base

 Wunderlich

