

MOTORGEHÄUSESCHUTZ

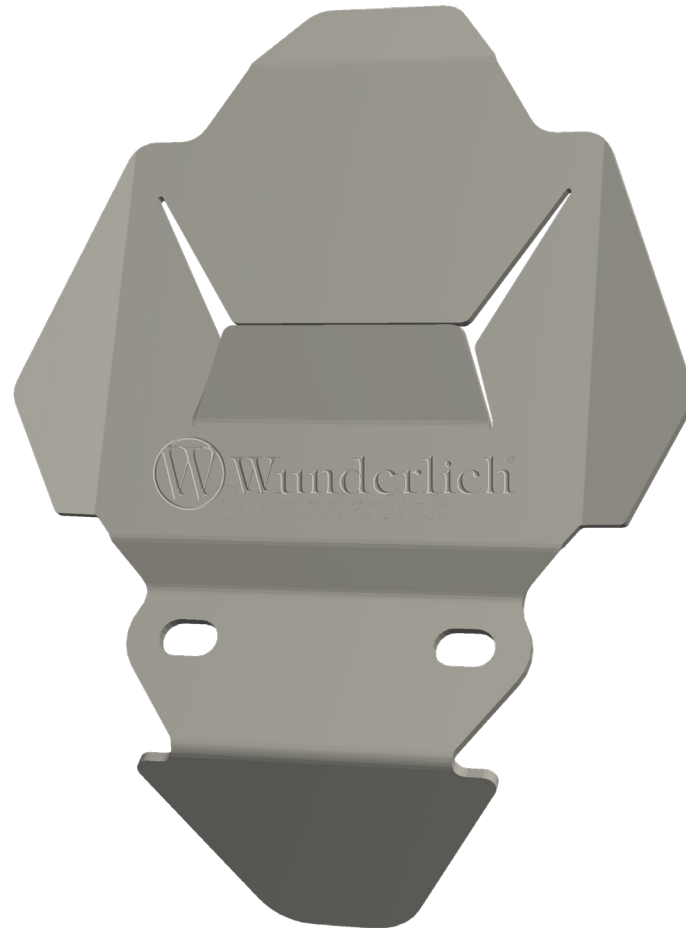

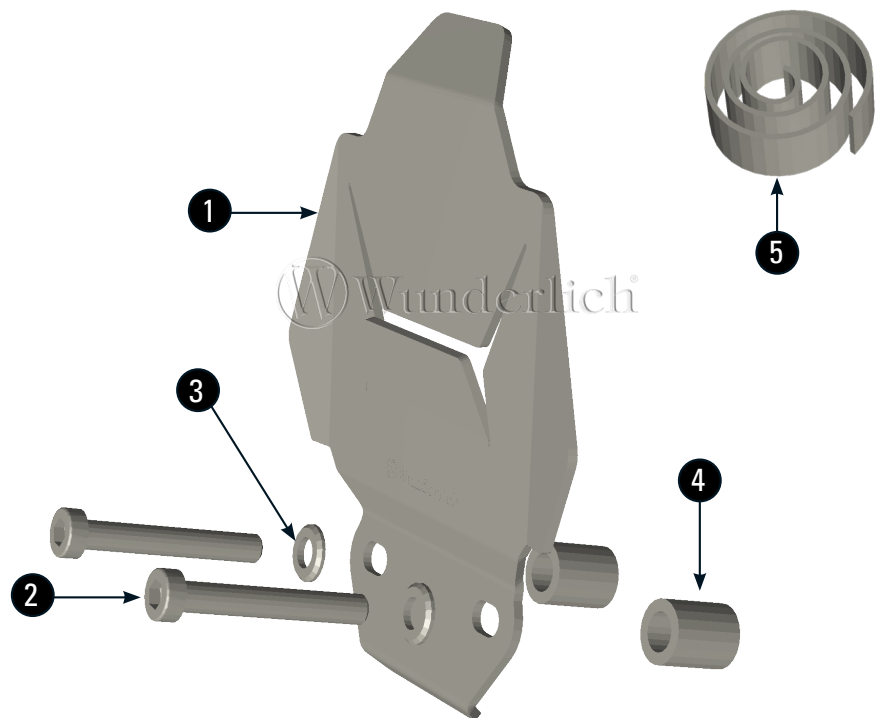



Engine Protection Plate | Protector de motor | Protection pour moteur | Protezione carter motore

Art.-Nr: 42770-XXX





LEGENDE / KEY

-  Anbau Tipp
Fitting tip
-  Achtung
Attention
-  Vergrößerung
Magnification
-  Schraube
Screw
-  Schraubensicherung
Thread locking fluid
-  Drehmoment
Torque

#	BEZEICHNUNG	MENGE
1	Motorgehäuseschutz	1
2	Zylinderschraube M6x40 (12Nm)	2
3	Unterlegscheibe M6	2
4	Hülse	2
5	Moosgummi	1

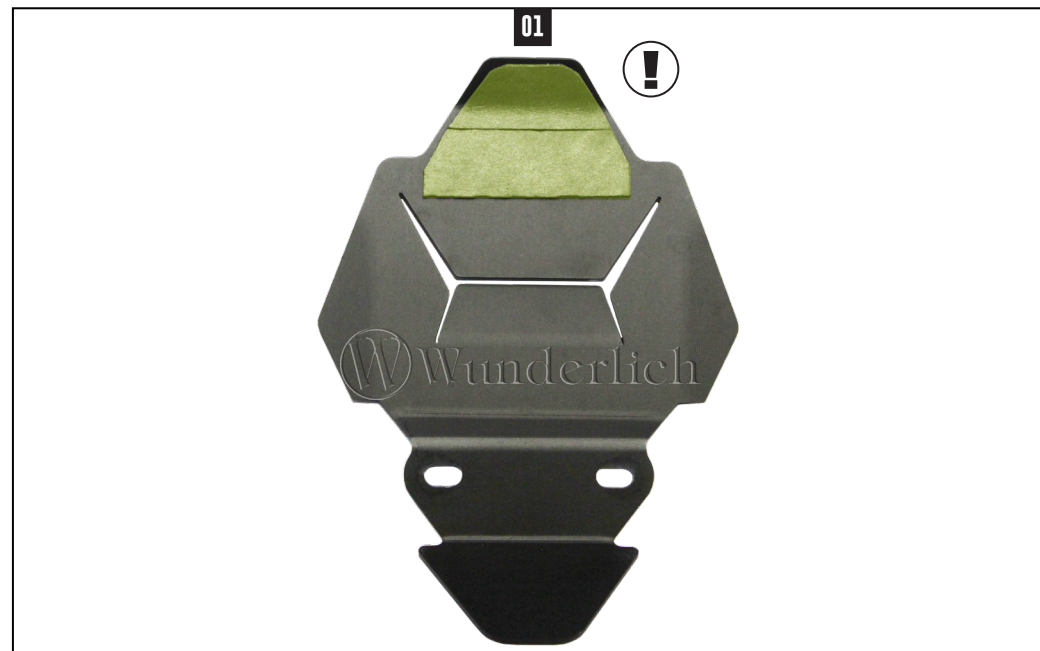

! Markierte Fläche mit Moosgummi bekleben.
Paste marked surface with moos rubber

