



Lenkererhöhung



Handle bar risers



Riser manubrio



Réhausse de Guidon



Alzas maniolla



30990-101



/WunderlichGmbH

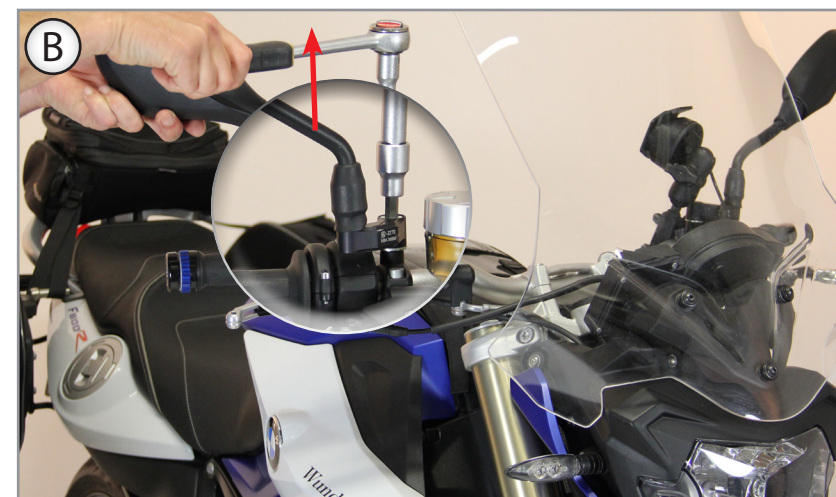
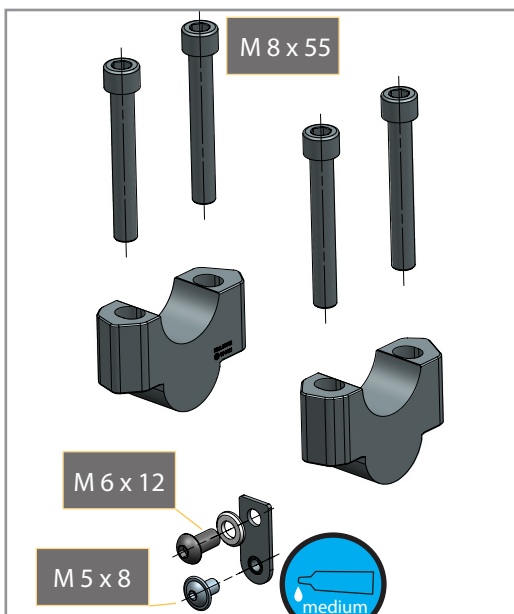

IN FO!



Für die Montage muss die Bremsleitung umgelegt werden (Bremskreislauf wird nicht geöffnet). Die Bremshebelarmatur ist so zu positionieren, dass die Leitung wie im Bild D2 genügend Spiel hat um die Bremszange hindurchzuführen!



For mounting the brake line must be allocated (but the brake circuit stays connected). Brake lever switch unit has to be positioned as shown in picture D2, so that the line has enough space for leading the brake caliper through!

News, Shop, Downloads + Informationen:
www.wunderlich.de

Kataloganforderung + Downloads:
www.wunderlich.de/Katalog

Catalogue download (English):
www.wunderlich.de/en

General information, dealers and news:
www.wunderlich.de/en

Download catalogo (italiano):
www.wunderlich.de/en

Informazioni generali, dealer e Novità:
<http://www.wunderlich.de/en>



Télécharger les catalogues (français):
www.wunderlich.de/en

Informations générales et distributeurs:
www.wunderlich.de/en

Descargar los catálogos (español):
www.wunderlich.de/en

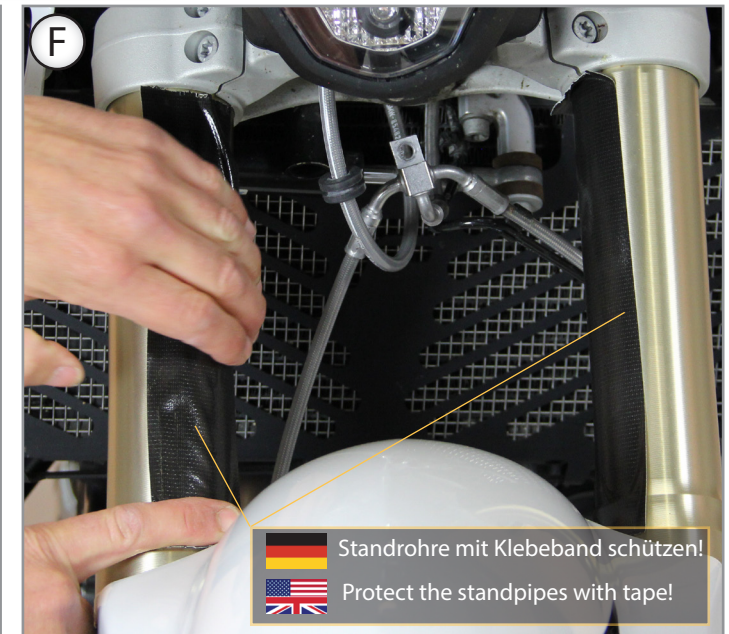
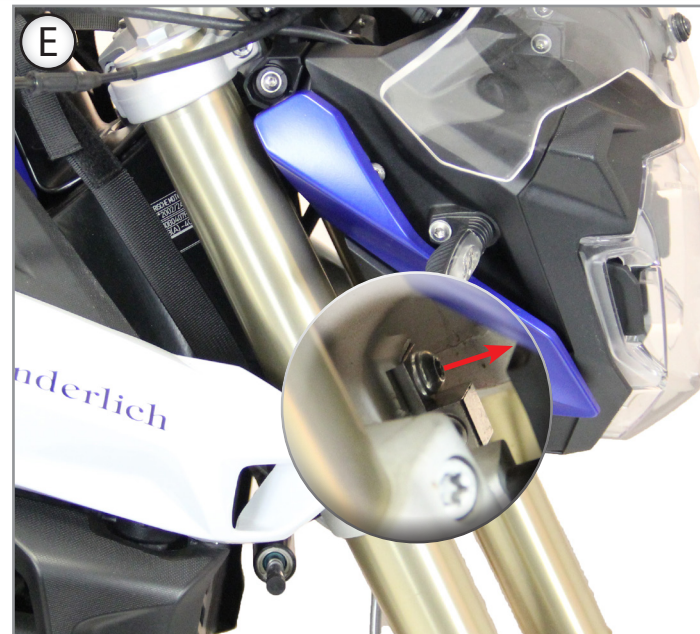
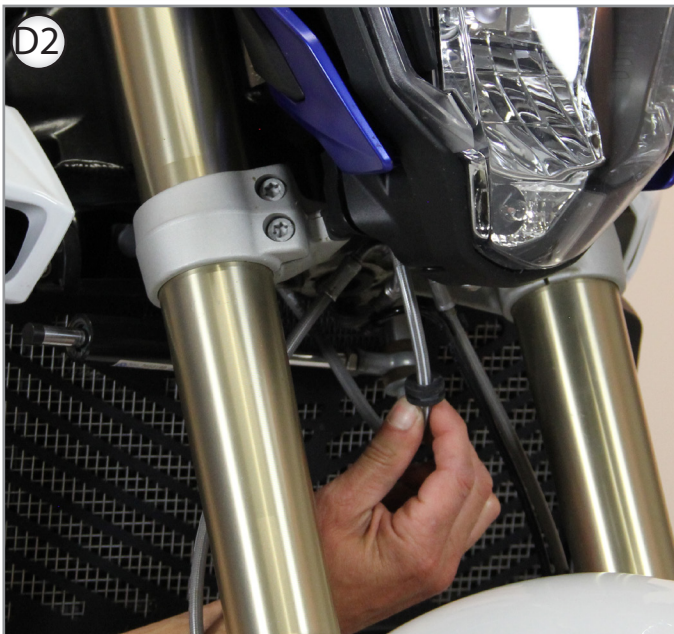
Informaciones generales, tiendas y noticias:
www.wunderlich.de/en



 Standrohre mit Klebeband schützen!
 Protect the standpipes with tape!

