

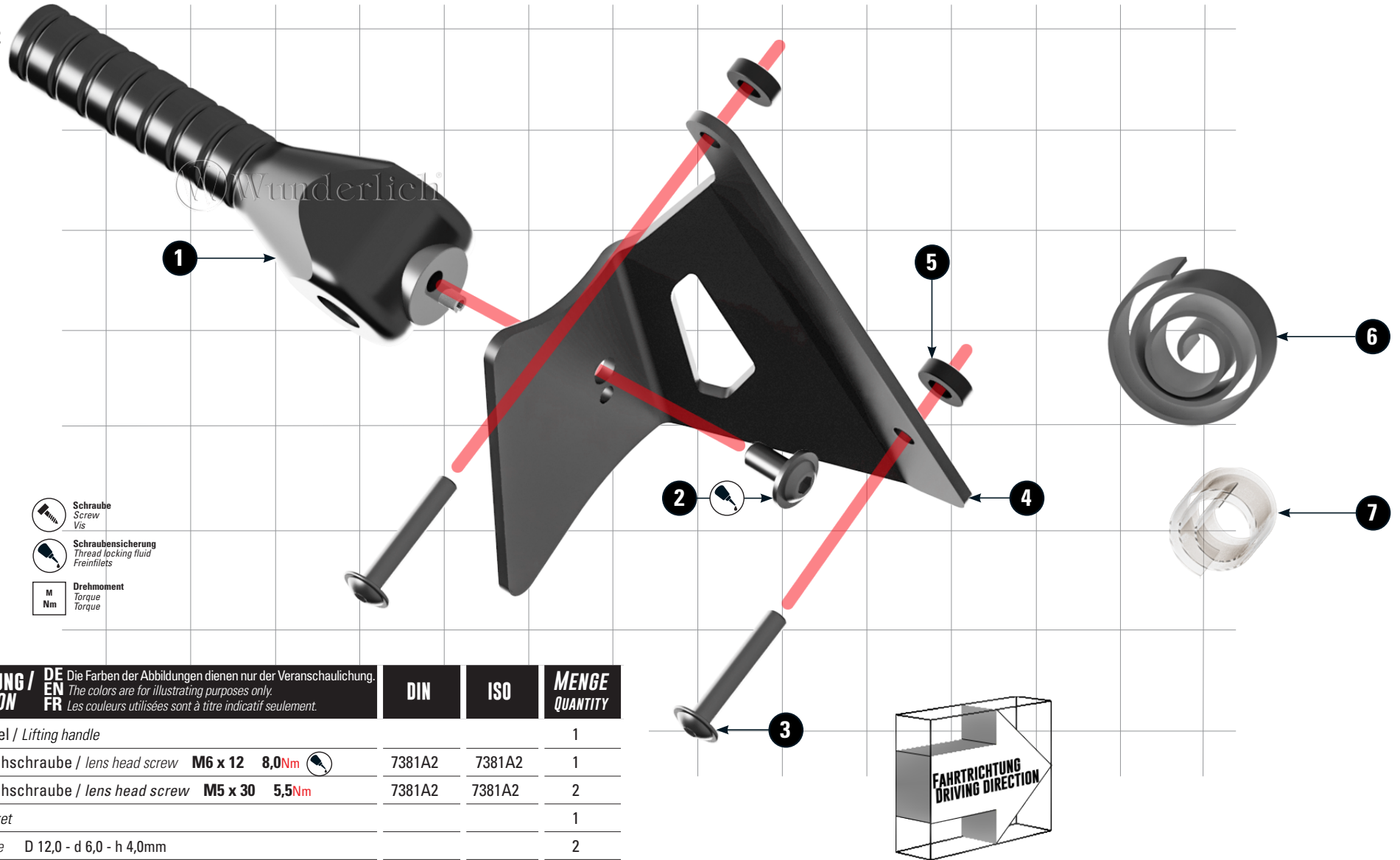



AUFBOCKHEBEL KLAPPBAR



Lifting handle foldable | Palanca plegable de elevación | Levier de cric repliable | Maniglia di sollevamento ribaltabile

Art.-Nr: 26201-002



LEGENDE/KEY/FILE LÉGENDE

-  **Anbau Tip**
Fitting tip
Astuce de montage
-  **Achtung**
Attention
Attention
-  **Vergrößerung**
Magnification
Grossissement
-  **Montagepaste**
Fitting lubricant
Lubrifiant de montage

-  **Schraube**
Screw
Vis
-  **Schraubensicherung**
Thread locking fluid
Freiniflets
-  **Drehmoment**
Torque
Torque

#	BEZEICHNUNG / DESCRIPTION	DE EN FR	Die Farben der Abbildungen dienen nur der Veranschaulichung. The colors are for illustrating purposes only. Les couleurs utilisées sont à titre indicatif seulement.	DIN	ISO	MENGE QUANTITY
1	Aufbockhebel / Lifting handle					1
2	Linsenflanschschraube / lens head screw					1
3	Linsenflanschschraube / lens head screw					2
4	Halter / bracket					1
5	Hülse / sleeve		D 12,0 - d 6,0 - h 4,0mm			2
6	Moosgummi / foam rubber					10cm
7	Lackschutzfolie / paint protection film					20cm





MARKIERTE FLÄCHE GRÜNDLICH REINIGEN UND LACKSCHUTZFOLIE AUFKLEBEN.

Thoroughly clean the marked area and stick on the paint protection film.
 Nettoyez soigneusement la zone marquée et collez le film de protection de la peinture.



MARKIERTE FLÄCHE GRÜNDLICH REINIGEN UND MOOSGUMMI AUFKLEBEN. SCHRAUBEN ENTFERNEN.

Thoroughly clean the marked area and stick on the foam rubber. Remove screws.
 Nettoyez soigneusement la zone marquée et collez le caoutchouc mousse.



ANLIEGENDE FLÄCHE GRÜNDLICH REINIGEN UND MOOSGUMMI AUFKLEBEN.

Thoroughly clean the contact surface and stick on foam rubber.
 Nettoyez soigneusement la surface adjacente et collez sur du caoutchouc mousse.

